



AMERICAN COMFORT WORLDWIDE

Owner's Manual

Mini Cooler/Air Conditioner

Model No: ACWI00

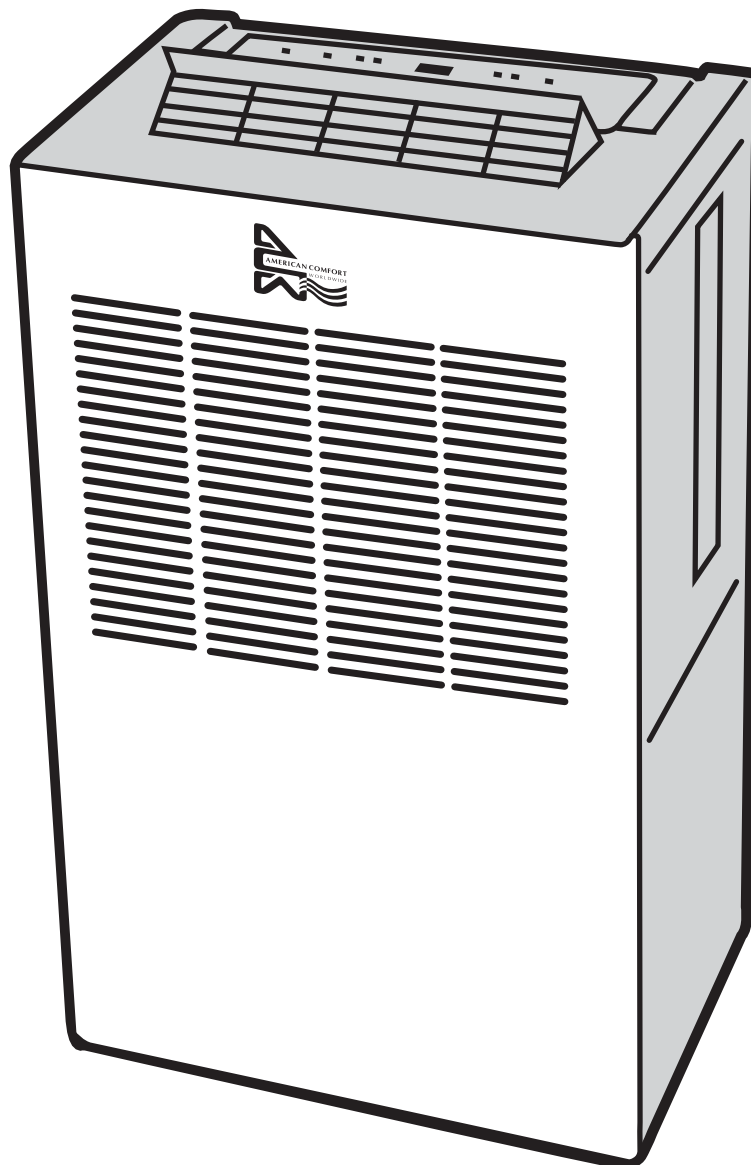

It is important that you read these instructions before using your new purchase and we strongly recommend that you keep them in a safe place for future reference.



Thank You	2
Safety	3
Specifications	4
Parts	5
Positioning	6
Operation	7-8
Emptying the Water Tank	9
Cleaning	10
Storage	12
Troubleshooting	11
Limited Warranty	12

Thank You!

Thank you for choosing this innovative ACW Mini Portable Air Conditioner. We suggest that you keep this manual in a safe place for future reference. It describes the many benefits and advanced features this unique product has to offer. Before you use your cooler you should carefully read these instructions to maximize this product's performance.

American Comfort Worldwide has specialized in complete indoor environmental control, manufacturing and marketing; dehumidifiers, portable air conditioners, coolers, air purifiers, ionizers and aroma therapy scent diffusers. These world class products incorporate the latest technological developments.

Safety Instructions

- Remove all packaging materials from the unit, keep it away from babies and small children to avoid the danger of suffocation.
- Before inserting the plug make sure that the voltage is within the range indicated on the rating label on the unit.
- The mini air conditioner is intended exclusively for the use for which it was created. ACW is not responsible for any damage caused by improper use.

IMPORTANT!

- The unit is designed for personal space cooling. It is not designed to an entire room.
- Rating: This unit must be connected to a 115 V / 60 Hz grounded outlet.
- The installation must be in accordance with regulations of the country where the unit is used.
- Do not connect the unit to an electrical outlet using an extension cord. If an outlet is not available, one should be installed by a licensed electrician.
- The mini air conditioner is safe, however as with other electrical appliances, use it with care.
- Unplug when not in use. Do not unplug by pulling the cord.
- Do not operate this product with wet hands.
- Keep out of the reach of children.
- Do not clean the unit by spraying it or immersing it in water.
- Disconnect it from the outlet before cleaning the unit or any of its components.
- Always unplug before changing the carbon filter (See page 9).

If you are in any doubt about the electrical installation, have it checked and if necessary modified by a qualified electrician.

Safety

- Never operate this appliance if it is damaged or if it has a damaged cord or plug. Please refer to our warranty and follow the instructions noted.
- Do not lead the cord over sharp edges.

A damaged supply cord should be replaced by the manufacturer, its service agent or a qualified person in order to avoid a hazard.

Do not use your air conditioner:



If the power cable wires are frayed or cut



When small children may be left unattended

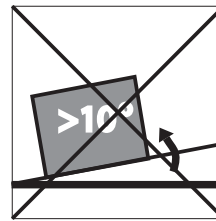

On a slope or uneven surface



Close to a heat source

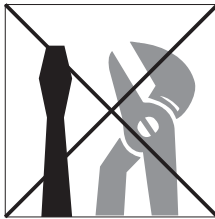

This products is not made for DIY repair

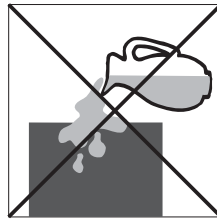

If there is a risk of liquid falling on the unit

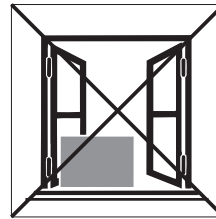

Inside unit exposed to the weather outdoors

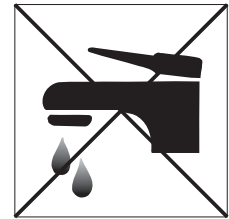

In a permanent very humid environment

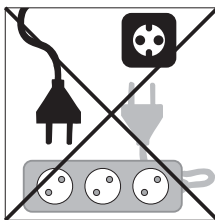

Do not connect the unit to an extension cord.

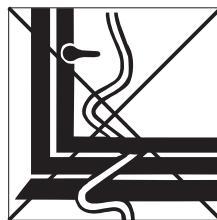

Where the power cable may be damaged



Where it may be damaged by chemicals

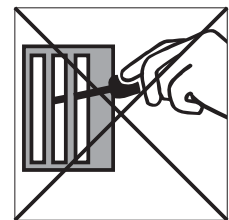

Where there is a risk of interference by foreign objects

IMPORTANT:

The first time that you use the unit, please ensure that it has been standing in an upright position for at least 2 hours before it is switched on.

The unit is not to be used in temperatures under 41°F or over 95°F.

Specifications

Model	ACW100
Power Supply	115V / 60 Hz / 1 Phase
Power Consumption: Dehumidifying	250 watts
Power Consumption: Cooling	240 watts
Cooling Capacity	1,000 BTUs
Refrigerant	R410A
Dehumidification	25 pints / 24 hrs.
Levels of Dehumidification:	2 Levels
Fan Speeds	2 speeds
Water Tank Capacity	13 pints
Operating Temperature	41°F - 95°F
Dimensions	14"W x 23"H x 9"D
Net Weight	26.5 lbs.
<p>The cooling capacity of the unit may be affected by the height of your ceiling, quality of your insulation, or number of windows in your room.</p> <p>There is no current testing statute for portable air conditioning products in the United States, yet we have made every effort to design engineer a superior quality portable air conditioning unit that effectively and efficiently cools select areas of the home or office.</p> <p>These portable air conditioning units are designed engineered to provide supplemental air conditioning. To gain a better understanding of the performance capabilities of your new ACW portable AC unit, you can visit us online at: www.americancomfort.com/portableacdisclaimer</p>	



Reminder:

Waste electrical products must not be disposed of with household waste.

This product should be taken to your local recycling center for safe processing.

Parts

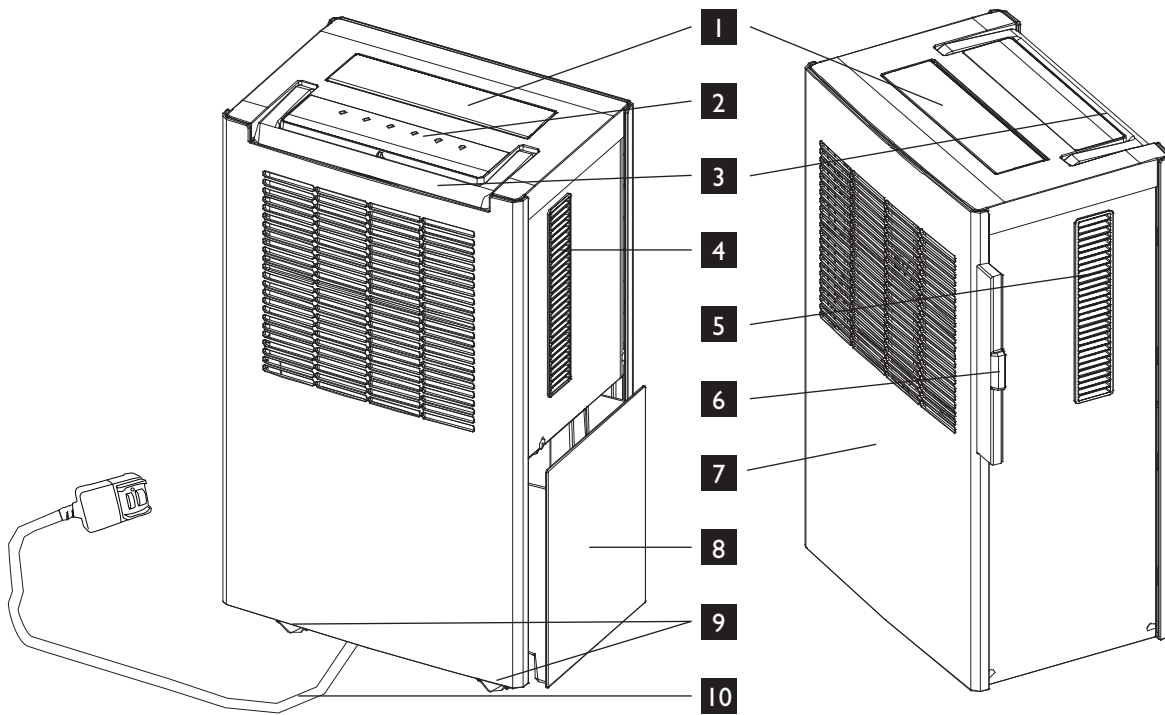

- | | |
|------------------|-----------------|
| 1. Air outlet | 6. Filter frame |
| 2. Control panel | 7. Front cover |
| 3. Handle | 8. Water tank |
| 4. Right panel | 9. Castors |
| 5. Left panel | 10. Power cord |

OPTIONAL: Carbon Filter

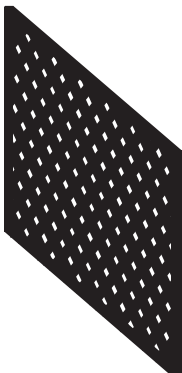

If Unit Is Not Operating:

1. If unit doesn't turn on, press top reset button on plug. The green light should be on.
2. If the Water Full indicator light is lit on the control panel, make sure the unit is unplugged from any electrical source and drain the tank before restarting.

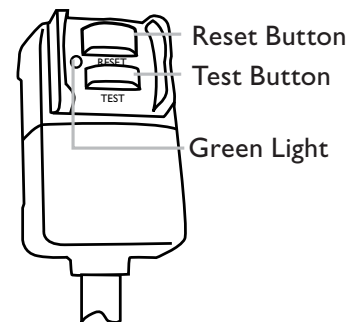

Positioning

The ACW mini portable air conditioner is really a three-in-one comfort appliance.

- Personal space cooling
- Effective room dehumidifier
- Air cleaner that filters dust, pollen and odors

As a dehumidifier your ACW mini portable air conditioner will begin to protect your home from the harmful effects of excessive moisture as soon as it is turned on.

Excess moisture travels throughout your home, in the same way that cooking smells spread to every room in the house. For this reason, the dehumidifier should be positioned in a central and clear location so that it can draw this moist air towards it from all over the home. A warm hallway or landing is an excellent position for your dehumidifier. If possible, leave interior doors ajar to allow air circulation.

Alternatively, if you have a serious problem in one area you can begin by positioning the dehumidifier there and later moving it to a more central point.

For the most effective use, run your dehumidifier with external doors and windows kept closed when the dehumidifier is operating. Please note the unit should not be placed directly against a radiator or other heat source.

When positioning your ACW mini portable air conditioner, ensure that it is placed securely on a level surface clear of any obstacle that may limit the air movement.

Your ACW Mini Portable Air Conditioner is fitted with 4 castors for easy movement, and requires no ducting.

IMPORTANT:

Keep a minimal 8" safety distance between the appliance and a wall, a heating source, and/or any inflammable surface.

Before you move the unit, switch it off and empty the water tank.

Operation

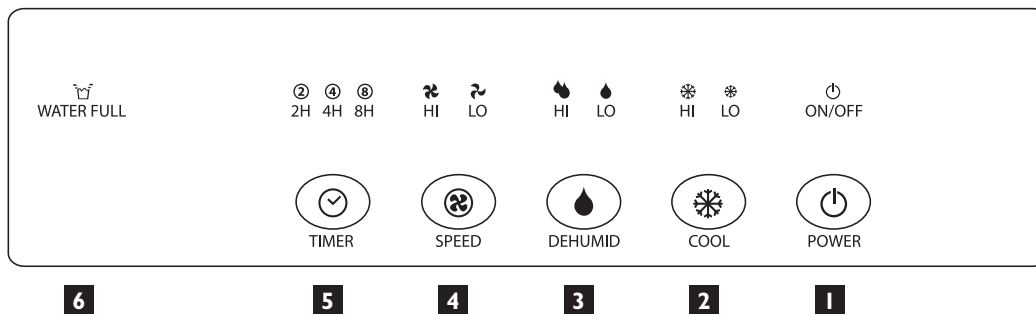



When the power cord is connected to the electrical outlet, the unit is ready for operating after a short buzzing sound.

1. ON/OFF



Press the ON/OFF BUTTON to switch on. The on/off indicator  will turn green. If the unit does not turn on, press the top reset button on the plug. The green light on the plug will indicate the unit is receiving power. At the same time the on/off indicator will turn green.

When the cooler is running, press the ON/OFF BUTTON to switch it off.



2. Cooling

If you choose to have your unit operate with only the dehumidification function, press the  BUTTON to select the level of cooling, the corresponding LED will lit:
 HI (orange) for strong cooling or  LO (green) for mild cooling.

3. Dehumidifying

Press the  BUTTON to select the required level of dehumidification, the louvre will close and the unit will start to dehumidify, the corresponding LED will lit:
 LO (green) for mild dehumidification or  HI (orange) for strong dehumidification. When the relative humidity in the room is high and you want to dry the room quickly, use the HI dehumidification.

4. Fan speed

Press the  BUTTON to select the required fan speed, the corresponding LED will lit:
 LO (green) for low speed or  HI (orange) for high speed.

5. Timer

Press the  BUTTON to select for how many hours the cooler should continue to operate: 2, 4 or 8 hours, the corresponding LED (2H, 4H or 8H) will turn green. The unit will stop working once the selected time has run down. When the compressor is shut down due to a power outage, the timer needs to be reset. But if the compressor is stopped due to water tank full condition or defrosting, the timer setting will remain as set

Operation

6. Red Warning Light

When the water tank is full, the unit automatically stops, the WATER TANK FULL LED  will turn red to signal that the tank must be emptied.

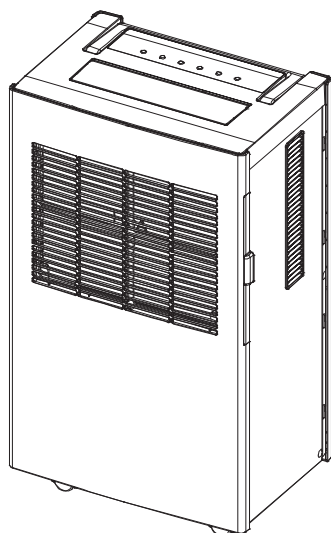

Louvers closed:
Dehumidifying Mode

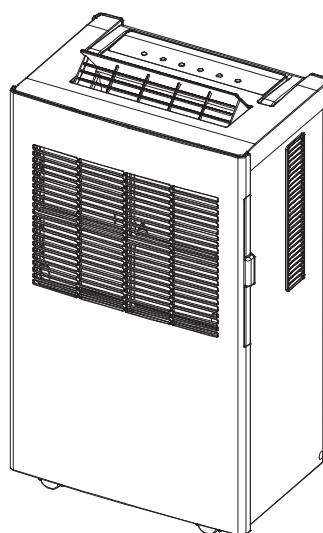

Louvers open:
Cooling Mode

Important:

- The compressor will start approximately 3 minutes after the unit is turned on (this will help prolong the life of the compressor). After switching the unit off, please wait at least 3 minutes before turning the unit back on.

Emptying The Water Tank

When the water tank is full, the unit will switch off automatically and beep 15 times, the TANK FULL LED  on the control panel will light up. The tank needs to be emptied:

- Make sure unit is unplugged from power source
 - Remove the water tank by pulling the clasp under the bottom.
 - Empty the water tank.
 - Push the water tank gently back in place. Plug the unit back into power source. When done properly, the WATER FULL LED will turn off.
1. Do NOT remove the float sensor device from the water tank. If removed, the water full sensor will no longer be able to detect the water level correctly without the float and water may leak from the water tank.
 2. If the water tank is dirty, wash it with cold or lukewarm water. Do not use detergent, scouring pads, chemically treated dust cloths, as these can scratch and damage the tank and cause water leakage.
 3. When inserting the drainage tank, press the tank firmly into place with both hands. If the tank is not positioned properly, the sensor will still be activate, and dehumidification can not operate.

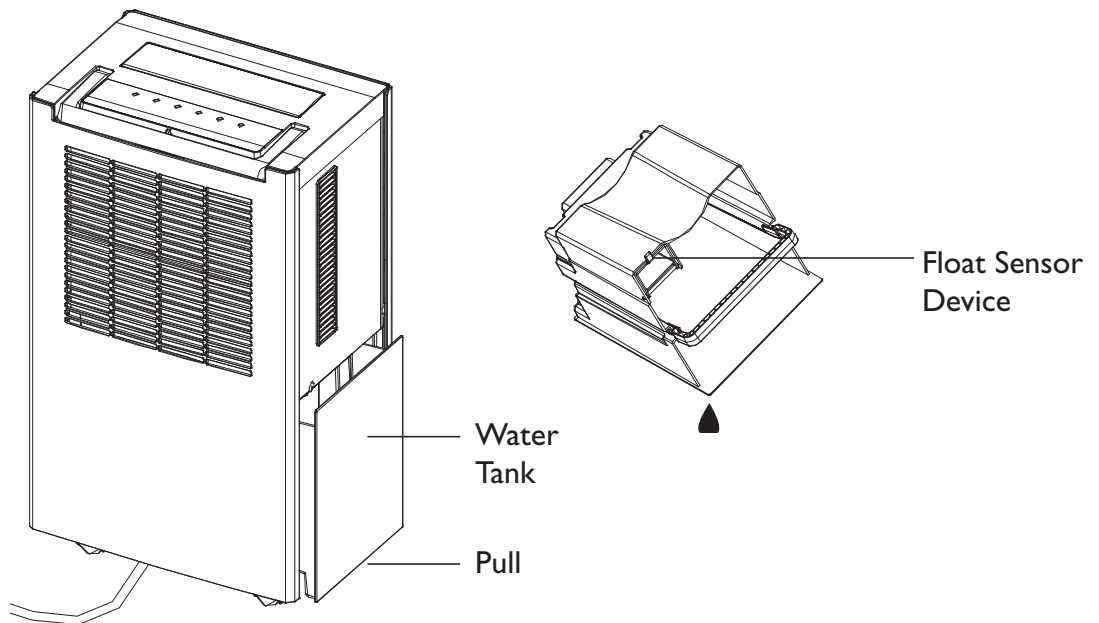

Cleaning

Always unplug the unit from the outlet before carrying out any maintenance or cleaning the unit.

Cleaning the Body

Use only a soft cloth to wipe the unit clean.

Do not use volatile chemicals, gas, detergents, chemically treated cloths or other harmful cleansing solutions. These could all possibly damage the cabinet.

Cleaning the Washable Air Filter

This cooler is equipped with a washable filter. It will capture most airborne pollutants like dust, smoke, animal dander, mold spores and pollen.

It is advisable to check the filter on a regular basis (at least monthly and after storage) and clean as necessary:

- Extract the filter holder
- Use a vacuum cleaner or tap the filter lightly

If the filter is very dirty, use luke-warm water with a small amount of medium strength detergent and rinse thoroughly under the cold water tap.

Make sure the filter is completely dry before replacing.

Do not expose the filter to sunlight or other sources of direct heat as this may cause the filter and frame to warp.

Important:

The optional carbon filter may not be washed, replace when dirty (every 3-6 months, depending on usage).

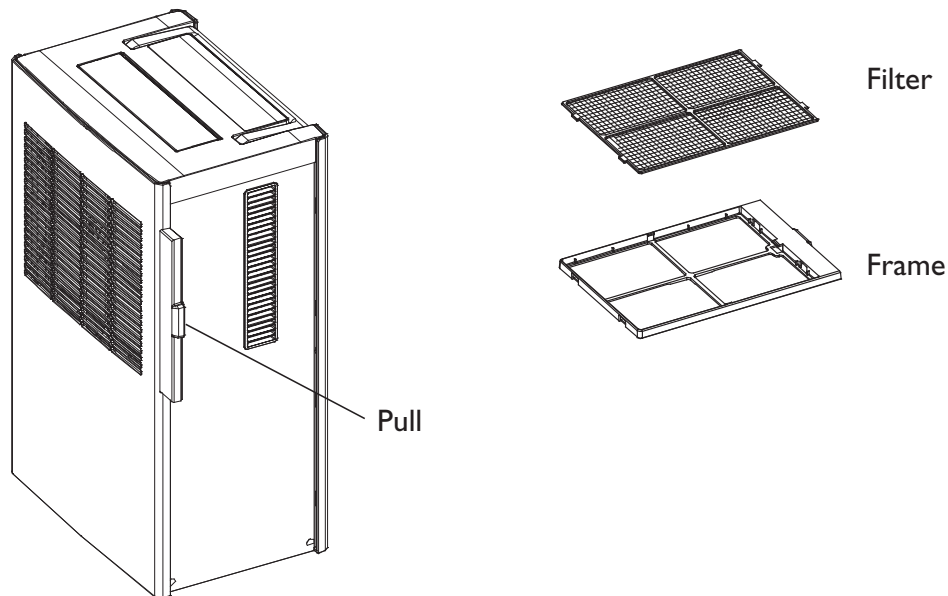

Storage

When your ACW Mini Portable Air Conditioner will not be used for a longer period of time:

- Drain the condensed water from the tank completely.
- Make sure tank is dry completely before storage to avoid mold/bacteria build up that can be hazardous to your health. We suggest allowing the unit and the water tank to separately air dry for a period of 24 hours.
- Clean or change the filter.
- When all is dry and clean, fold the power supply cord and put it in the water tank.
- Protect the unit against dust (put back into its original carton) and store in a cool and dry place not accessible for children.
- Do not stock heavy objects on top of the unit.

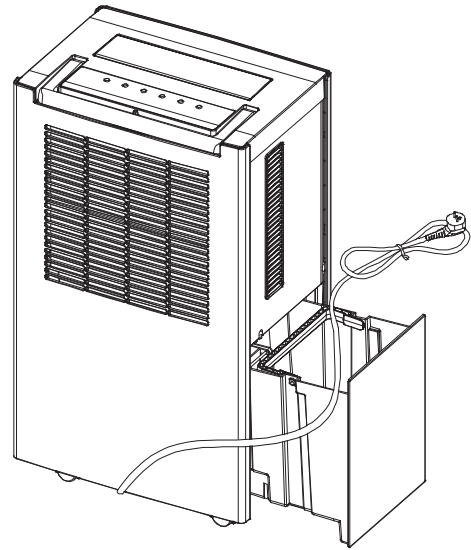

Troubleshooting

Never try to repair or dismantle the mini portable air conditioner yourself. Incompetent repairs result in loss of warranty and can endanger the user and the property. Before calling for assistance, please check these points.

Problem	Possible Cause	Solution
The unit doesn't operate.	No power supply.	Connect to a functioning outlet and switch on. If the unit does not turn on, press the top reset button on the plug. The green light on the plug will indicate the unit is receiving power. At the same time the on/off indicator will turn green. The unit is ready to be powered ON.
	Is the tank full light flashing?	Empty the water tank.
	Room temperature above 95°F.	The protection device is activated: the unit can not be started (see page 9).
The dehumidifying function doesn't work.	The filter is dirty.	Clean or replace the filter (see page 10).
	Air inlet or air outlet blocked.	Unplug the unit and remove the blockage.
No air is discharged.	The filter is dirty.	Clean or replace the filter (see page 10).
Operation is noisy.	The unit stands uneven	Place on an even, solid surface (less vibrations).
	The filter is clogged.	Clean or replace the filter. (see page 10).

AMERICAN COMFORT

WORLDWIDE

One Year Limited Warranty

American Comfort Worldwide LLC (“ACW”) warrants this ACW portable air conditioner to the original retail purchaser (“Purchaser”) purchasing only in the 48 Contiguous States, for one year from the date of purchase, against defects in material and workmanship under normal use and service. Should your ACW Portable air conditioner prove defective within one year from the date of purchase, please follow our return procedure to return the defective unit. Within the first 30 days, ACW is responsible for the freight cost to and from our authorized service center for all units with an ACW authorized RMA. After 30 days and up to life of warranty (12 months), customer is responsible for freight costs to and from our authorized service center.

ACW’s sole obligation under this warranty is to replace, or at ACW’s discretion, to repair, free of charge, all defective parts, for a period of one (1) year from date of original purchase. All replacement parts and units will be new, remanufactured, or refurbished. ANY IMPLIED WARRANTY OF MERCHANTABILITY IS SIMILARLY LIMITED TO ONE (1) YEAR FROM DATE OF ORIGINAL PURCHASE AND NO ACTION BASED UPON ANY IMPLIED WARRANTY OF MERCHANTABILITY OR OTHERWISE MAY BE COMMENCED AFTER EXPIRATION OF ONE (1) YEAR FROM DATE OF ORIGINAL RETAIL PURCHASE. Some states do not allow limitations on how long an implied warranty lasts, so the above limitation may not apply to you. Proof of Purchase (i.e. copy of receipt) must be sent with the unit.

The provisions of this warranty shall not apply to any product which in ACW’s judgment has been (1) subject to misuse or neglect. (2) damaged in an accident. (3) used for a purpose for which it was not designed, or (4) repaired or altered in any way that adversely affected its performance or reliability. Do not attempt to “open unit”, except for filter replacement. Opening unit will void manufacturer’s warranty.

THIS WARRANTY DOES NOT COVER:

- Damage, accidental or otherwise, to the unit while in the possession of the consumer not caused by a defect in material or workmanship.
- Damage caused by consumer misuse, tampering, or failure to follow the care and special handling provisions in the instructions.
- Damage to the finish of the case, or other appearance parts caused by the wear.
- Damage caused by repairs or alterations of the unit by anyone other than those authorized by American Comfort Worldwide.
- Freight and Insurance cost for the warranty service beyond 30 days from date of purchase up to life of warranty (12 months).

This warranty covers only new products purchased from our authorized dealers or retailers. It does not cover used, salvaged, or refurbished products.

To obtain warranty service, the defective product or part must be shipped or delivered to: American Comfort Worldwide, the Manufacturer. If warranty applies under ACW’s approved terms, all Shipping charges and insurance are covered by purchaser.

AMERICAN COMFORT WORLDWIDE NEITHER ASSUMES NOR AUTHORIZES ANY PERSON TO ASSUME FOR IT ANY OTHER (LIABILITY IN CONNECTION WITH ITS PRODUCTS, THERE ARE NO WARRANTIES WHICH EXTEND BEYOND THE DESCRIPTION ON THE FACE HEREOF. NO RESPONSIBILITY IS ASSUMED FOR INCIDENTAL OR CONSEQUENTIAL DAMAGES THAT MAY RESULT FROM THE USE OF AN ACW PRODUCT, NOR FOR THE DAMAGES DUE TO ACCIDENT, ABUSE, LACK OF RESPONSIBLE CARE, THE AFFIXING OF ANY UNAUTHORIZED ATTACHMENT, LOSS OF PARTS, OR USE AT A VOLTAGE OTHER THAN SPECIFIED. Some states do not allow the exclusion of limitation of incidental or consequential damages, so these limitations may not apply to you. ACW disclaims all liabilities for defects or damages caused by use of replacement parts obtained from or by service at any service center other than American Comfort Worldwide, the Manufacturer.

This warranty gives you specific legal rights, and you may also have other rights which vary from state to state.

QUESTIONS? Call 1-877-645-0299 • www.americancomfort.com

03/10

7092192202A

Dear Customer: Please keep this warranty for your records, along with a copy of the original receipt.
DO NOT return it.